

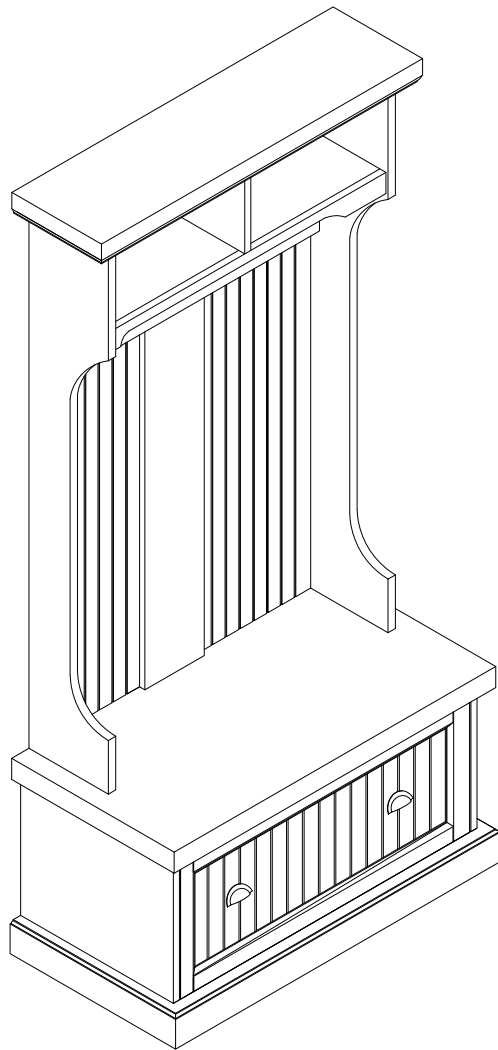

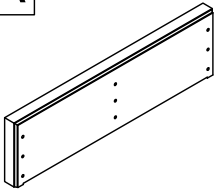

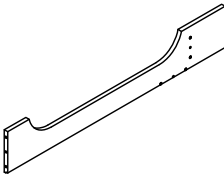

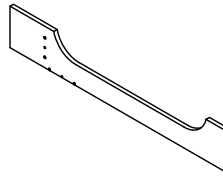

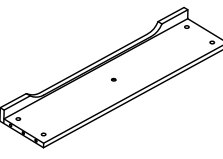
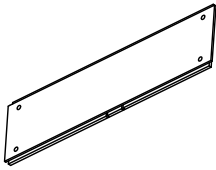
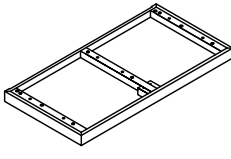
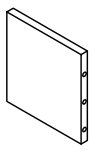
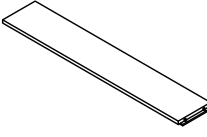
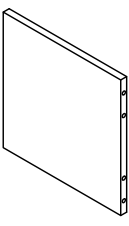
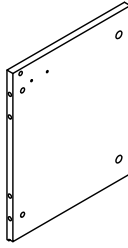
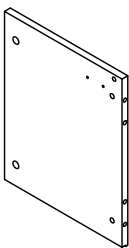
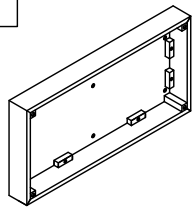
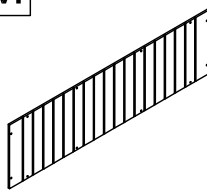
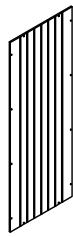
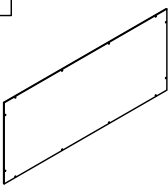
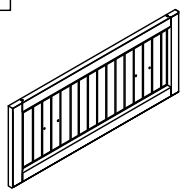

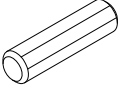
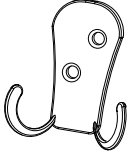

Hall Tree
CF6030

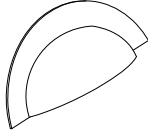
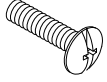
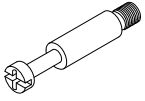
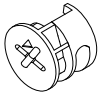
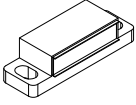

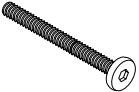
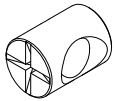
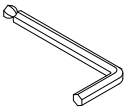
PART LIST

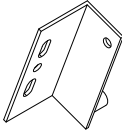
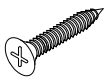
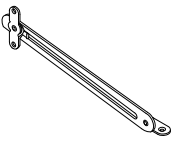
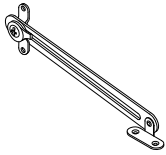
<p>A</p> 	<p>B</p> 	<p>C</p> 	<p>D</p> 	<p>E</p> 
<p>Top Panel 1 PC</p>	<p>Left Brace 1 PC</p>	<p>Right Brace 1 PC</p>	<p>Upper Fixed Panel 1 PC</p>	<p>Back Cross Bar 1 PC</p>
<p>F</p> 	<p>G</p> 	<p>H</p> 	<p>I</p> 	<p>J</p> 
<p>Seat Panel 1 PC</p>	<p>Upper Partition Panel 1 PC</p>	<p>Back Middle Brace 1 PC</p>	<p>Lower Partition Panel 1 PC</p>	<p>Left Panel 1 PC</p>
<p>K</p> 	<p>L</p> 	<p>M</p> 	<p>N</p> 	<p>O</p> 
<p>Right Panel 1 PC</p>	<p>Bottom Panel 1 PC</p>	<p>Top Back Panel 1 PC</p>	<p>Middle Back Panel 2 PCS</p>	<p>Bottom Back Panel 1 PC</p>
<p>P</p> 				
<p>Door Panel 1 PC</p>				

HARDWARE LIST

<p>#1</p>  <p>Ø8*30mm</p>	<p>#2</p> 	<p>#3</p> 	<p>#4</p> 	<p>#5</p>  <p>1/4"*Ø5/32"</p>
<p>Wood Dowel 30 PCS (Extra 1)</p>	<p>Hook 3 PCS</p>	<p>Bronze Screw 6 PCS</p>	<p>Handle 2 PCS</p>	<p>Round Head Bolt 4 PCS</p>
<p>#6</p> 	<p>#7</p> 	<p>#8</p> 	<p>#9</p> 	<p>#10</p>  <p>2"*Ø1/4"*D11mm</p>
<p>Cam Bolt 14 PCS</p>	<p>Cam Lock 14 PCS (Extra 1)</p>	<p>Magnet 1 PC</p>	<p>Round Head Screw 2 PCS (Extra 1)</p>	<p>Bolt 14 PCS</p>
<p>#11</p> 	<p>#12</p> 	<p>#13</p> 	<p>#14</p> 	<p>#15</p> 
<p>Barrel Nut 6 PCS</p>	<p>Allen Wrench 1 PC</p>	<p>Left Hinge 1 PC</p>	<p>Right Hinge 1 PC</p>	<p>Short Screw 6 PCS</p>
<p>#16</p> 	<p>#17</p> 	<p>#18</p> 	<p>#19</p> 	<p>#20</p> 
<p>Left Safety Hinge 1 PC</p>	<p>Right Safety Hinge 1 PC</p>	<p>Long Screw 8 PCS</p>	<p>Screw 48 PCS (Extra 1)</p>	<p>Safety Strap Kit 1 SET</p>

ADDITIONAL TOOLS (Not Provided)

Note: It is not recommended to use power tools during assembly.

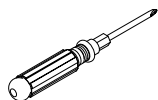

Phillips Head Screwdriver

Note: Wood dowels are intended for alignment. Additional clearance between wood dowel and pre-drilled hole is intentional for ease of assembly.

Step 1. Attach hinges (parts #13 & #14) to door panel (part P) using short screws (part #15) and phillips head screwdriver. Attach handles (part #4) to door panel (part P) using round head bolts (part #5) and phillips head screwdriver. Attached hooks (part #2) to back cross bar (part E) using bronze screws (part #3) and phillips head screwdriver.

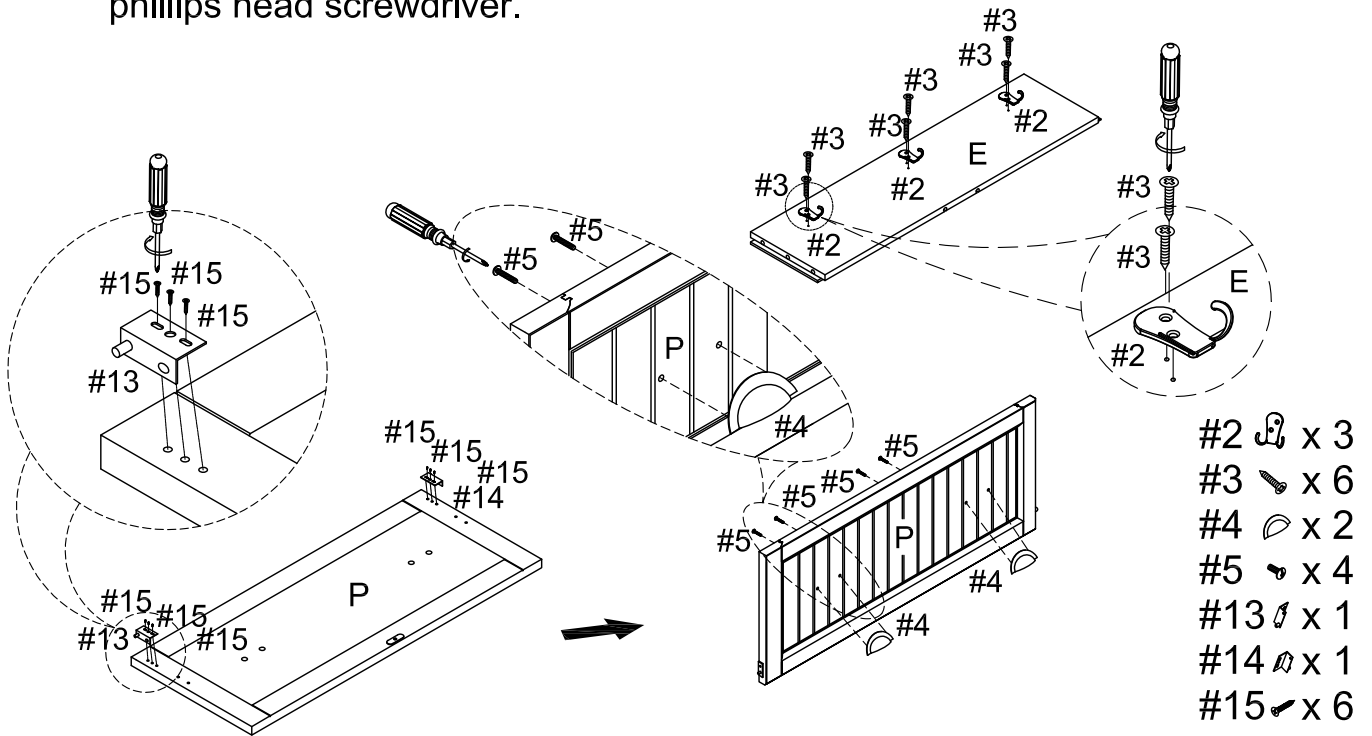

Step 2. Attach magnet (part #8) to seat panel (part F) using round head screws (part #9) and phillips head screwdriver. Attach cam bolts (part #6) to seat panel (part F) and braces (parts B & C) using phillips head screwdriver.

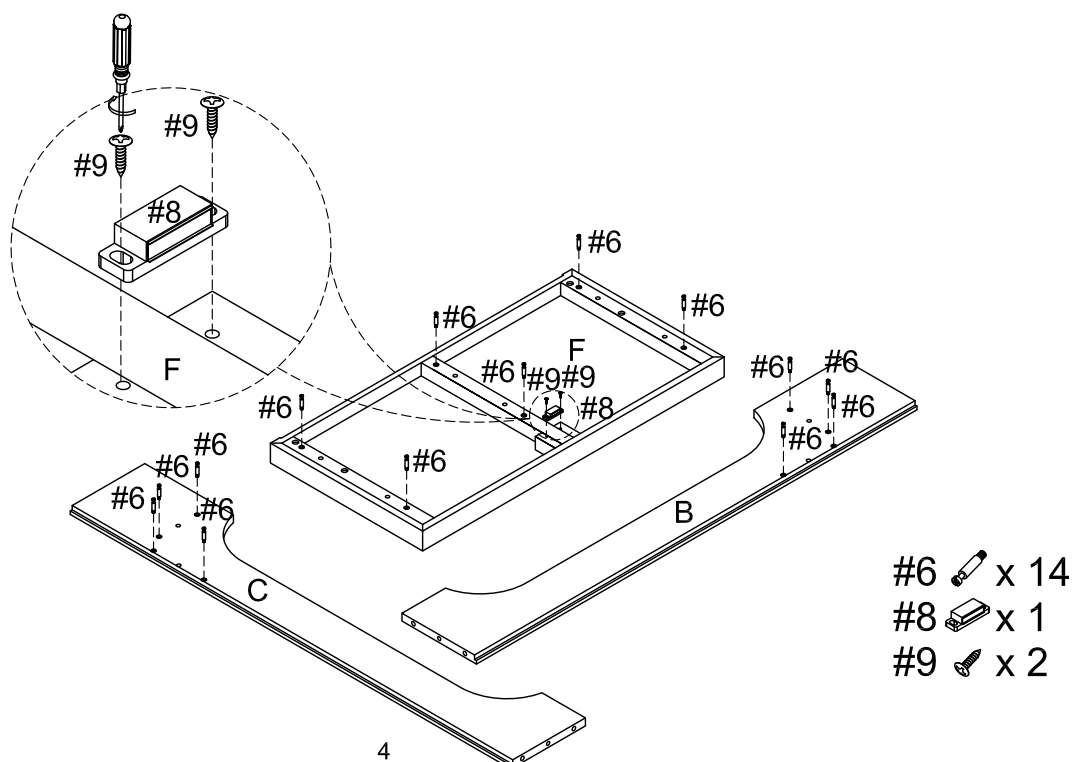

NOTE: Do not overtighten cam bolts. Stop tightening once threads on cam bolt are no longer visible.

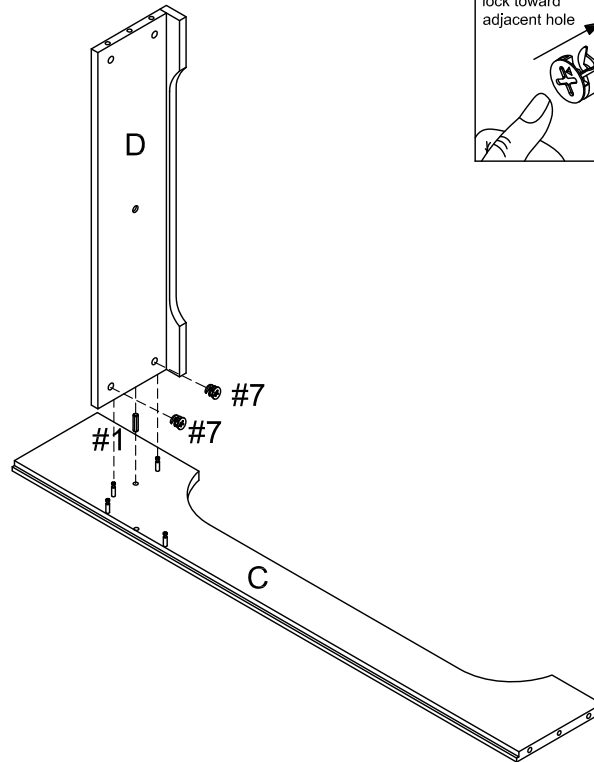
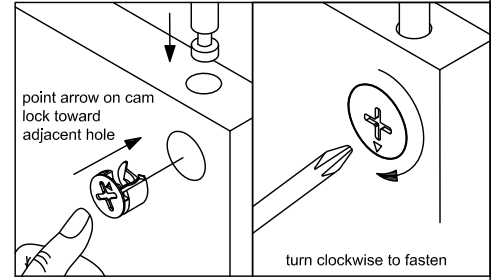

Step 3. Attach upper fixed panel (part D) to right brace (part C) using wood dowel (part #1) and cam locks (part #7).

NOTE: Cam locks must rotate a full 180°. See pictured insert.





#1  x 1
#7  x 2

Step 4. Attach back cross bar (part E) to right brace (part C) using wood dowel (part #1) and cam locks (part #7).

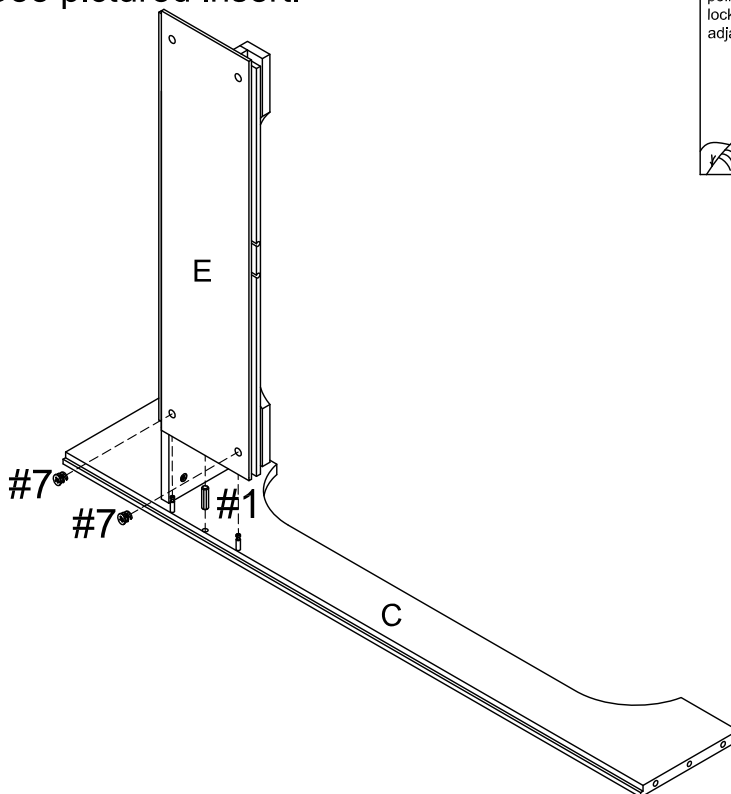
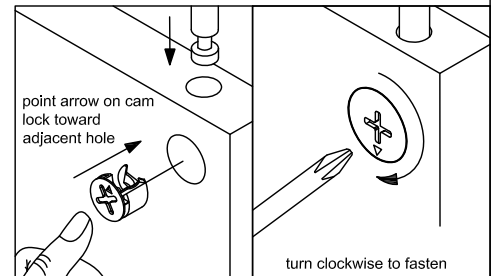
NOTE: Cam locks must rotate a full 180°. See pictured insert.





#1  x 1
#7  x 2

Step 5. Attach left brace (part B) to assembled unit (parts D & E) using wood dowels (part #1) and cam locks (part #7).

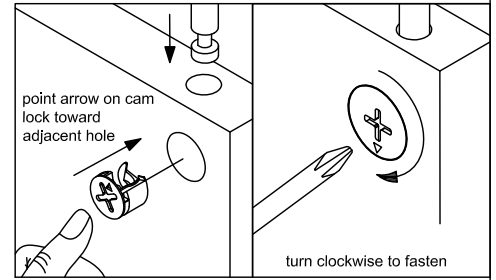
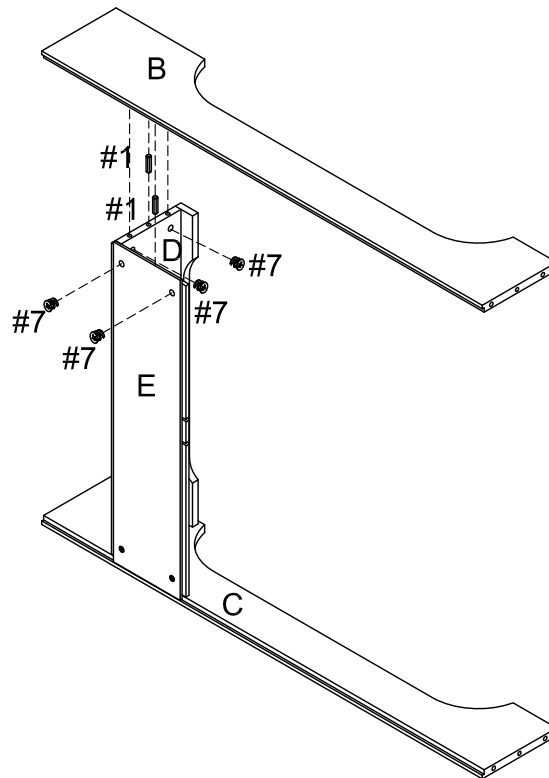
NOTE: Cam locks must rotate a full 180°. See pictured insert.





#1  x 2
 #7  x 4

Step 6. Attach top panel (part A) and upper partition panel (part G) to assembled unit (parts B, C & D) using wood dowels (part #1), bolts (part #10) and allen wrench (part #12).

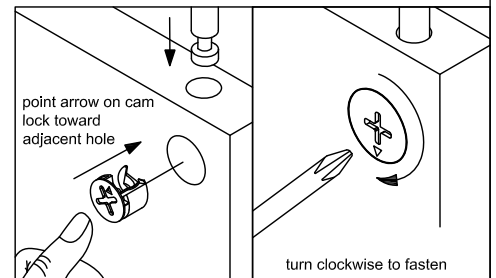
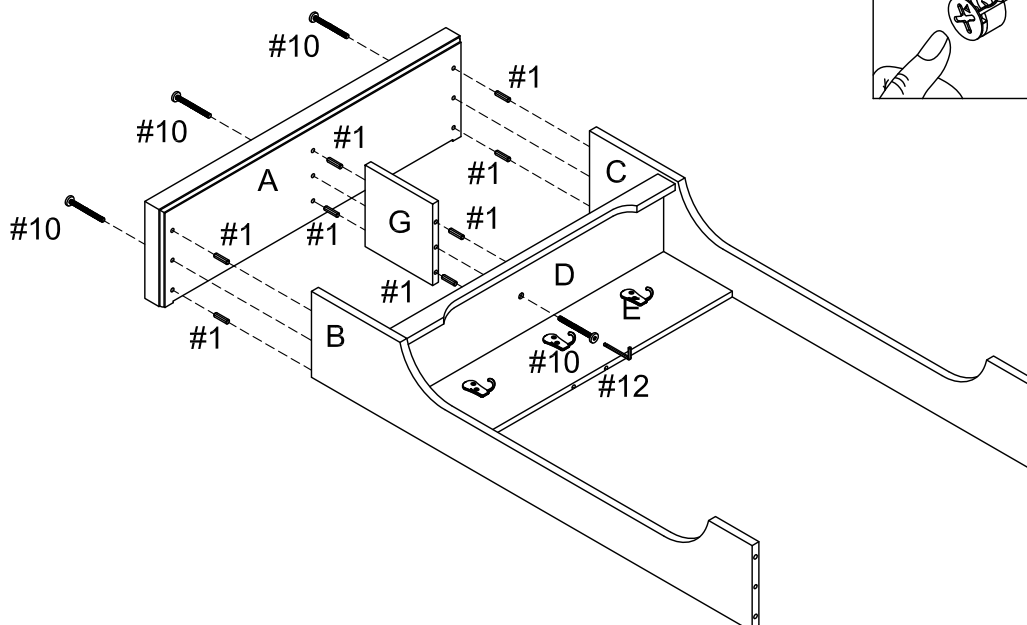
NOTE: Cam locks must rotate a full 180°. See pictured insert.



#1  x 8
 #10  x 4
 #12  x 1

Step 7. Attach seat panel (part F) and back middle brace (part H) to assembled unit (parts B, C & E) using wood dowels (part #1), bolts (part #10) and allen wrench (part #12).

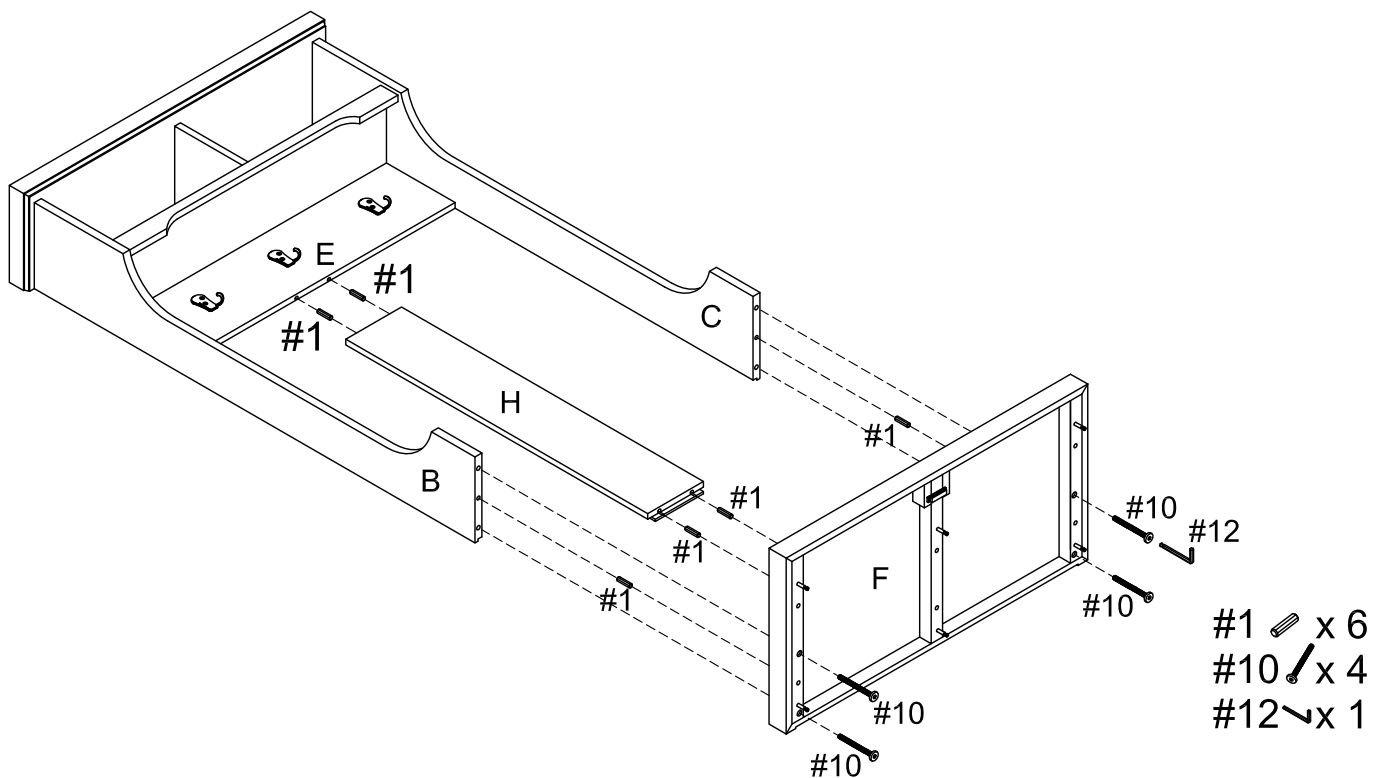

Step 8. Attach lower partition panel (part I) and panels (parts J & K) to seat panel (part F) using wood dowels (part #1) and cam locks (part #7).

NOTE: Cam locks must rotate a full 180°. See pictured insert.

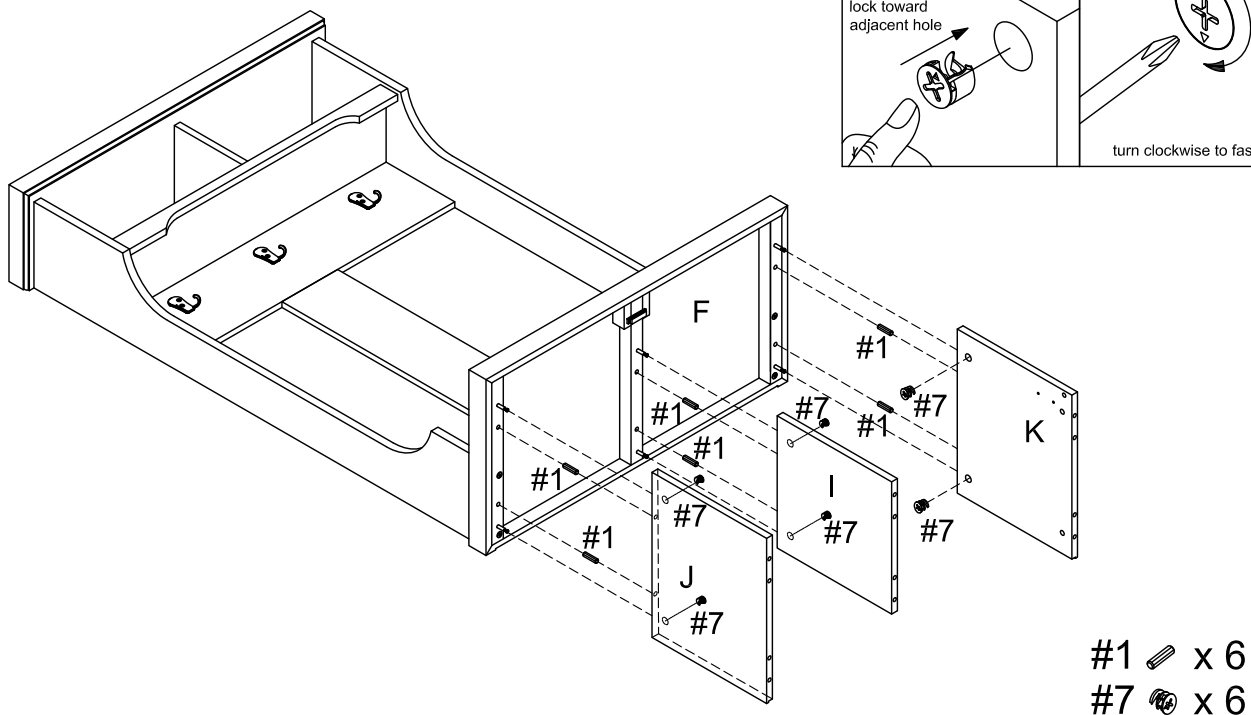
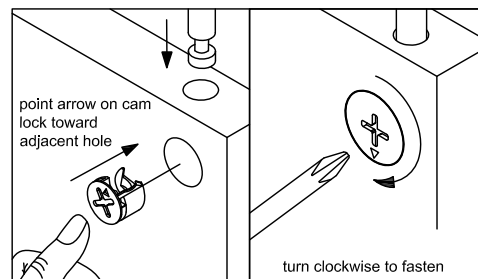

Step 11. Carefully turn unit upright. Attach back panels (parts M, N & O) to assembled unit (parts A, B, C, E, F, H, J, K & L) using screws (part #19) and phillips head screwdriver.

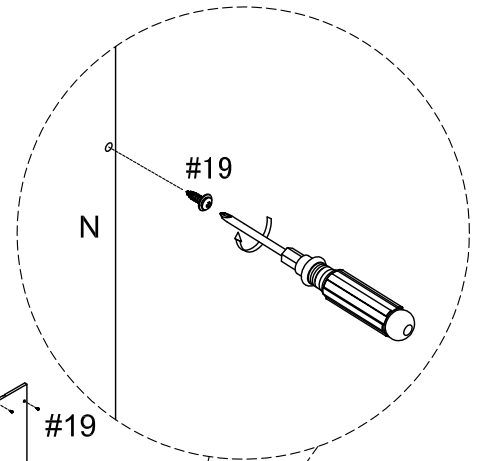
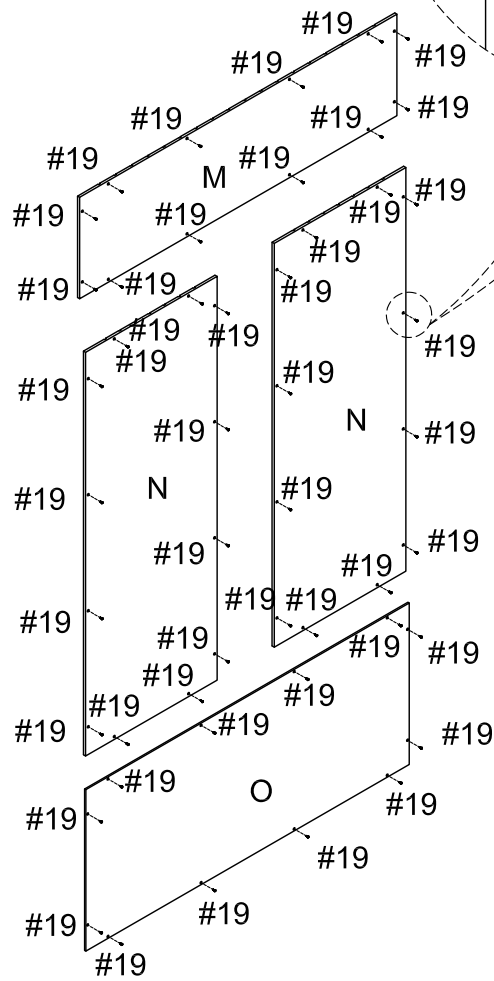
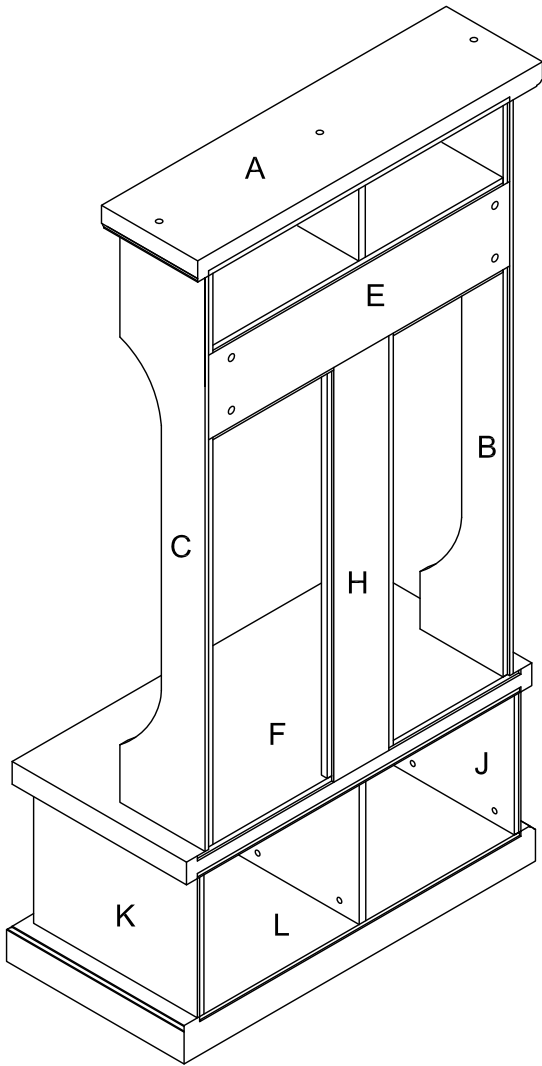





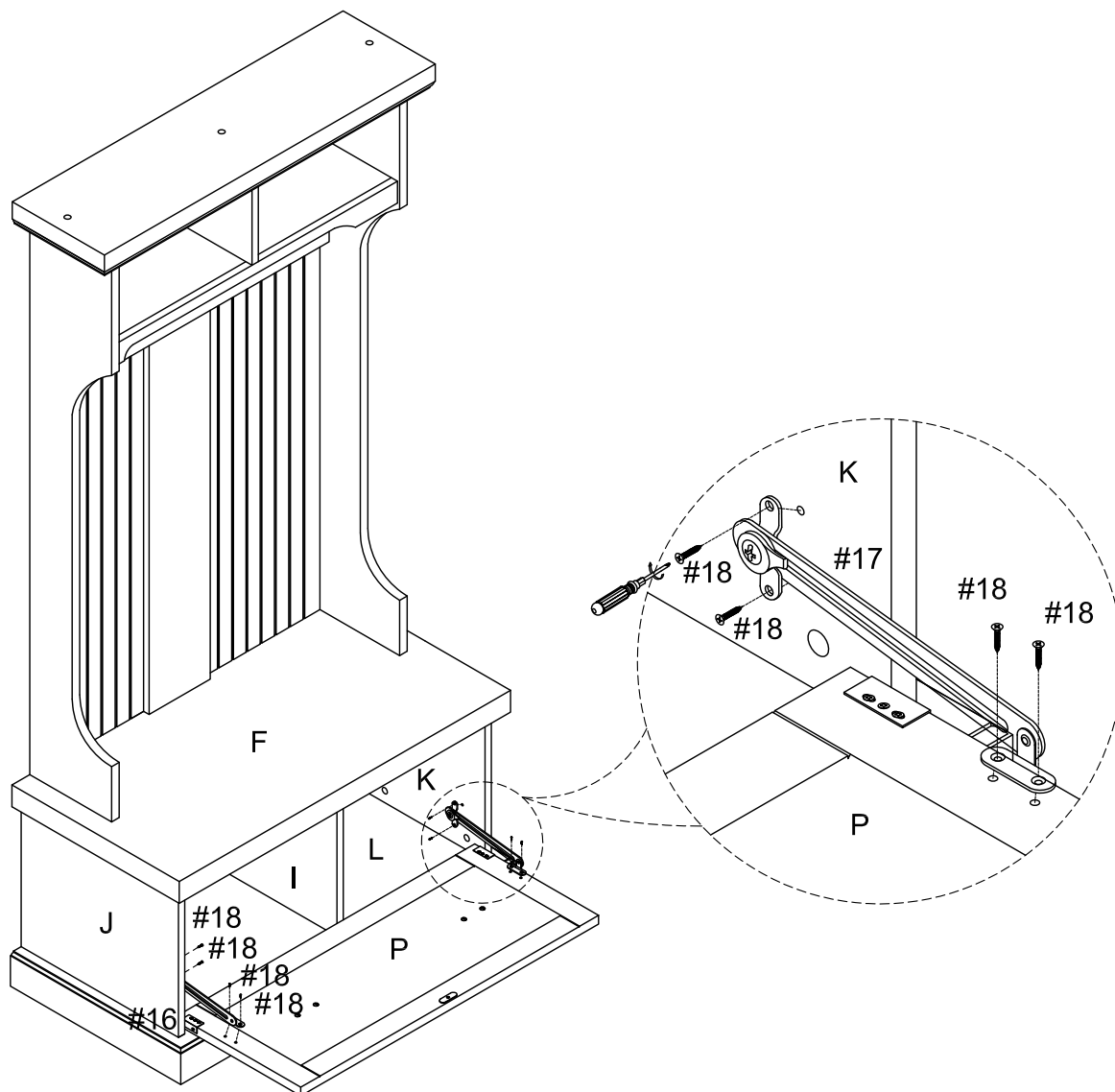

#19 x 48

Step 12. Attach safety hinges (parts #16 & #17) to panels (parts J & K) and door panel (part P) using long screws (part #18) and phillips head screwdriver.

Important: Safety strap kit (part #20) must be installed to prevent tipping, damage and/or injury.

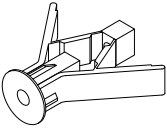

#16  x 1
#17  x 1
#18  x 8

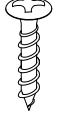
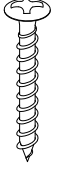
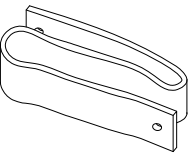
#20	A	B	C	D	E
			 D8*3/4"	 D8*1-1/2"	
Safety Strap Kit 1 SET	Wall Anchor 1 PC	Washer 2 PCS	Short Screw 1 PC	Long Screw 1 PC	Safety Wall Strap 1 PC

SAFETY WALL STRAP INSTALLATION

Note: It is highly recommended to install this safety strap kit to prevent tipping, damage and/or injury.

1. Insert short screw (C) through washer (B) and safety wall strap (E) and attach to top panel (part A) using phillips head screwdriver.
2. Drill a 11/32" hole where you want to secure the unit. The drilled hole will be at the same height as the hole in top panel (part A) where the safety wall strap (E) is attached. Tap wall anchor (A) into the hole.
3. Insert long screw (D) through washer (B) and safety wall strap (E) into wall anchor (A) using phillips head screwdriver.

Note: This item is not intended for clothing storage use.

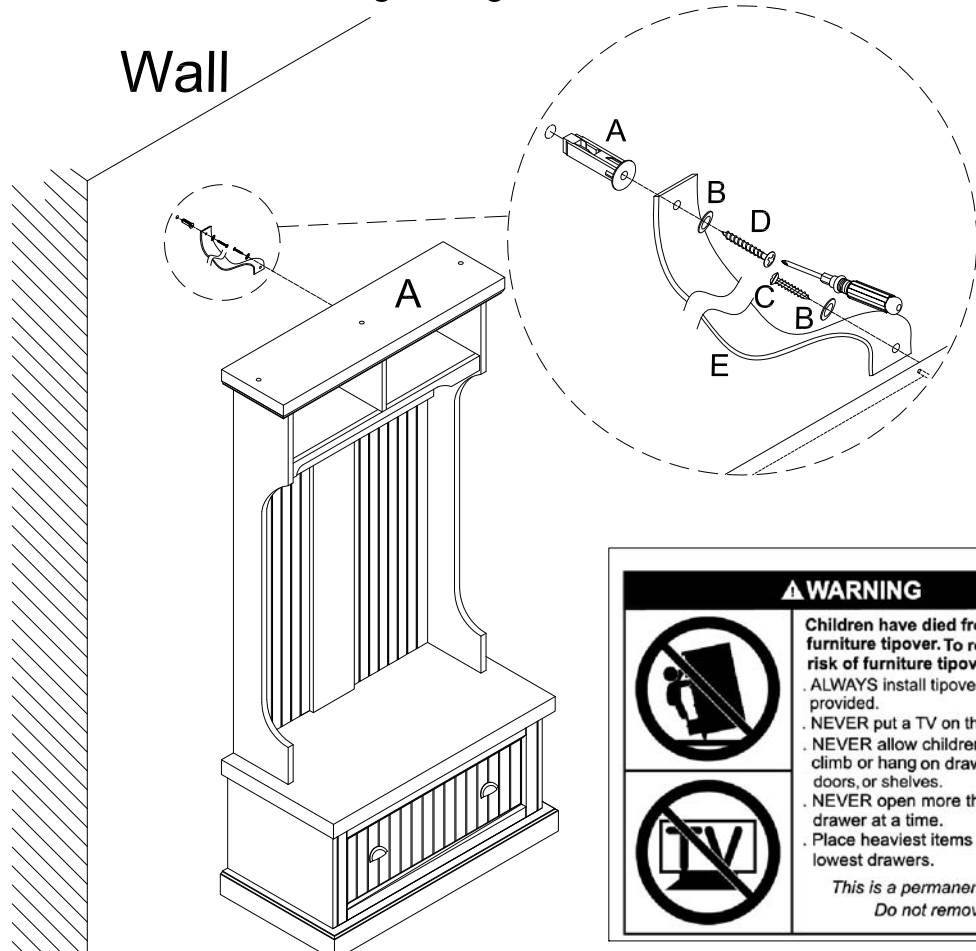

▲ WARNING	
	Children have died from furniture tipover. To reduce the risk of furniture tipover:
	<ul style="list-style-type: none"> ALWAYS install tipover restraint provided. NEVER put a TV on this product. NEVER allow children to stand, climb or hang on drawers, doors, or shelves. NEVER open more than one drawer at a time. Place heaviest items in the lowest drawers.
<p><i>This is a permanent label. Do not remove!</i></p>	